

Rated capacity limiter system OGM240-20

PN 102-1106

REZONANS

Operator Console



Controller SM
PN 100-6692

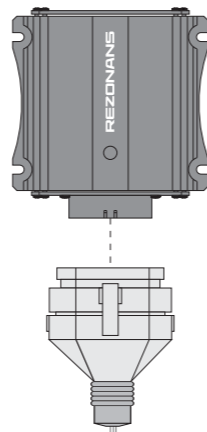

Running line tensiometer
boom hoist

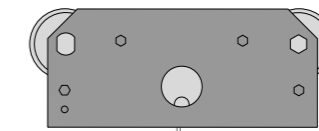

A2B switch



Wiring harness
PN 102-1488

Main/Aux hoist active +24V

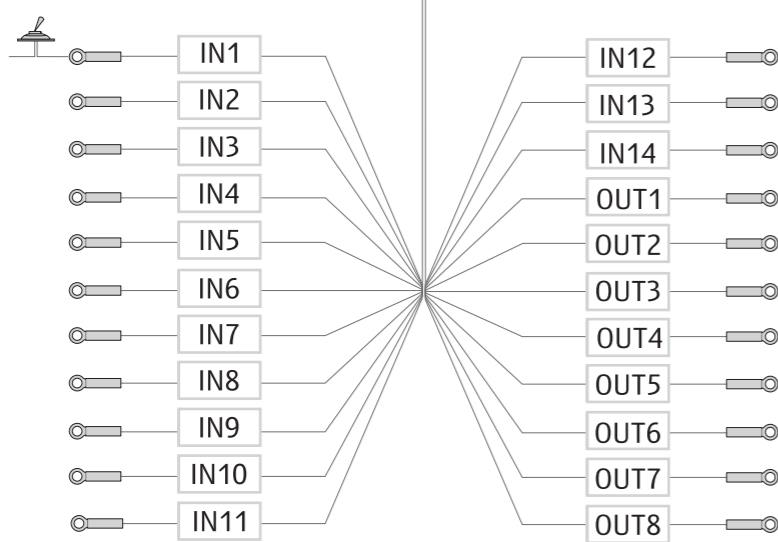

X6

- 1 OUT1
- 2 OUT2
- 3 OUT3
- 4 OUT4
- 5 OUT5
- 6 OUT6
- 7 OUT7
- 8 OUT8
- 9 IN1
- 10 IN2
- 11 IN3
- 12 IN4
- 13 IN5
- 14 IN6
- 15 IN7
- 16 IN8
- 17 IN9
- 18 IN10
- 19 IN11
- 21 IN12
- 22 IN13
- 23 IN14
- 28 +V
- 29 +V
- 30 R-Bus
- 31 +24V
- 35 GND

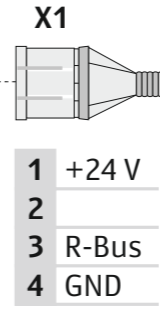
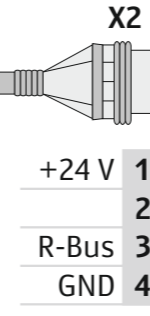
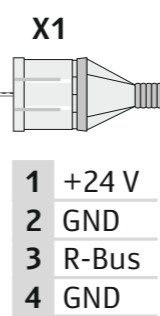
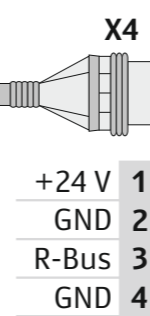
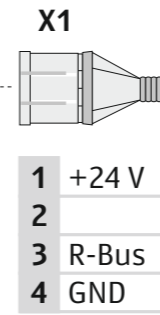
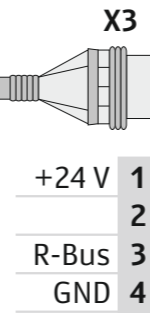

Running line tensiometer
jib aux hoist

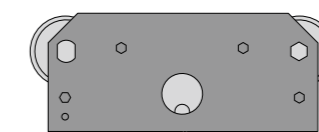

Cable reel with length and angle
sensor BSM50 series

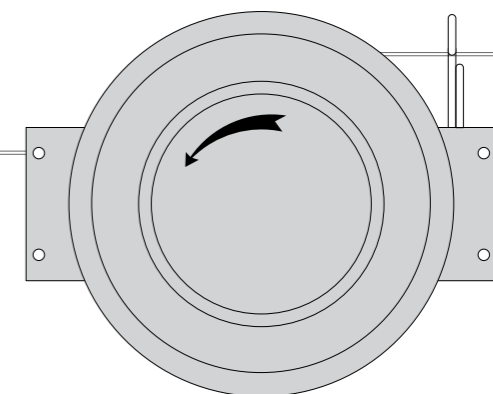

+24 V GND

Installation manual OGM240-20

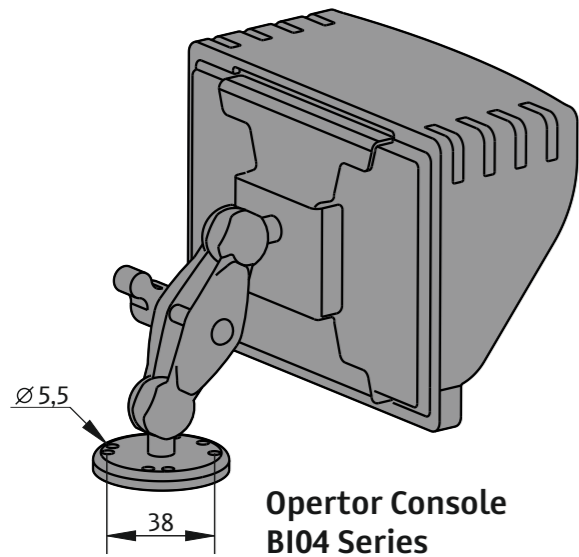

**Operator Console
B104 Series**

should be mounted in the operator's field of view but not obstruct sight during a lift. The attachment shall provide access to the buttons and USB connector for storage device.

1

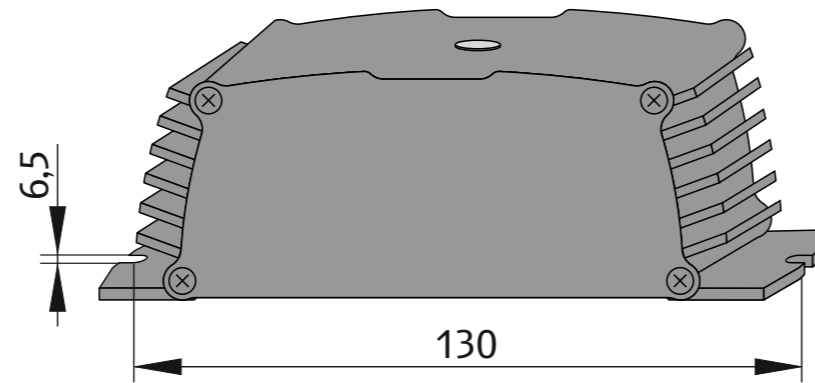

**Controller
SM Series**

should be mounted in the operator's room or junction box. The location should provide the ability to electrical connections crane.

3

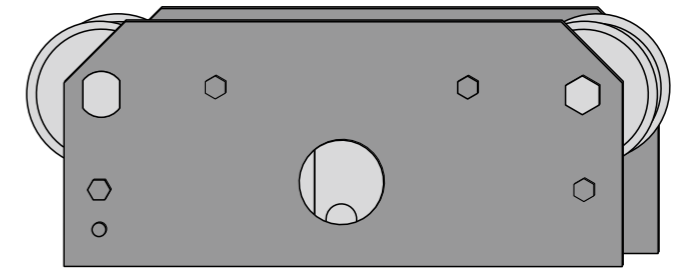

**Running line tensiometer
boom hoist and Running line
tensiometer jib aux hoist**

should be mounted as close to the lattice boom tip as possible. Base plate will be attached to the boom with the swing arm bolt affixed. The wire rope should be maintained according to standard practices (in good condition, properly lubricated) to ensure correct calibration.

4

2

Slewing Sensor

Azimuth sensor dua360.13 provides measurement of crane boom rotation angle. It was designed for mounting on a slewing ring or axis of crane rotation.

**Cable reel with length and angle
sensor BSM50 series**

Sensor must be mounting on the cab side of the first (lower) section of the main boom. Drum should rotate in the direction of the arrow during telescoping. Correct alignment of the first guide is important to ensure orderly winding of the cable on the reel. Install the other guides at the end of each of the intermediate sections and the anchor at the end of the last section

5

